

EXPLODED DIAGRAM OF ST/16-11

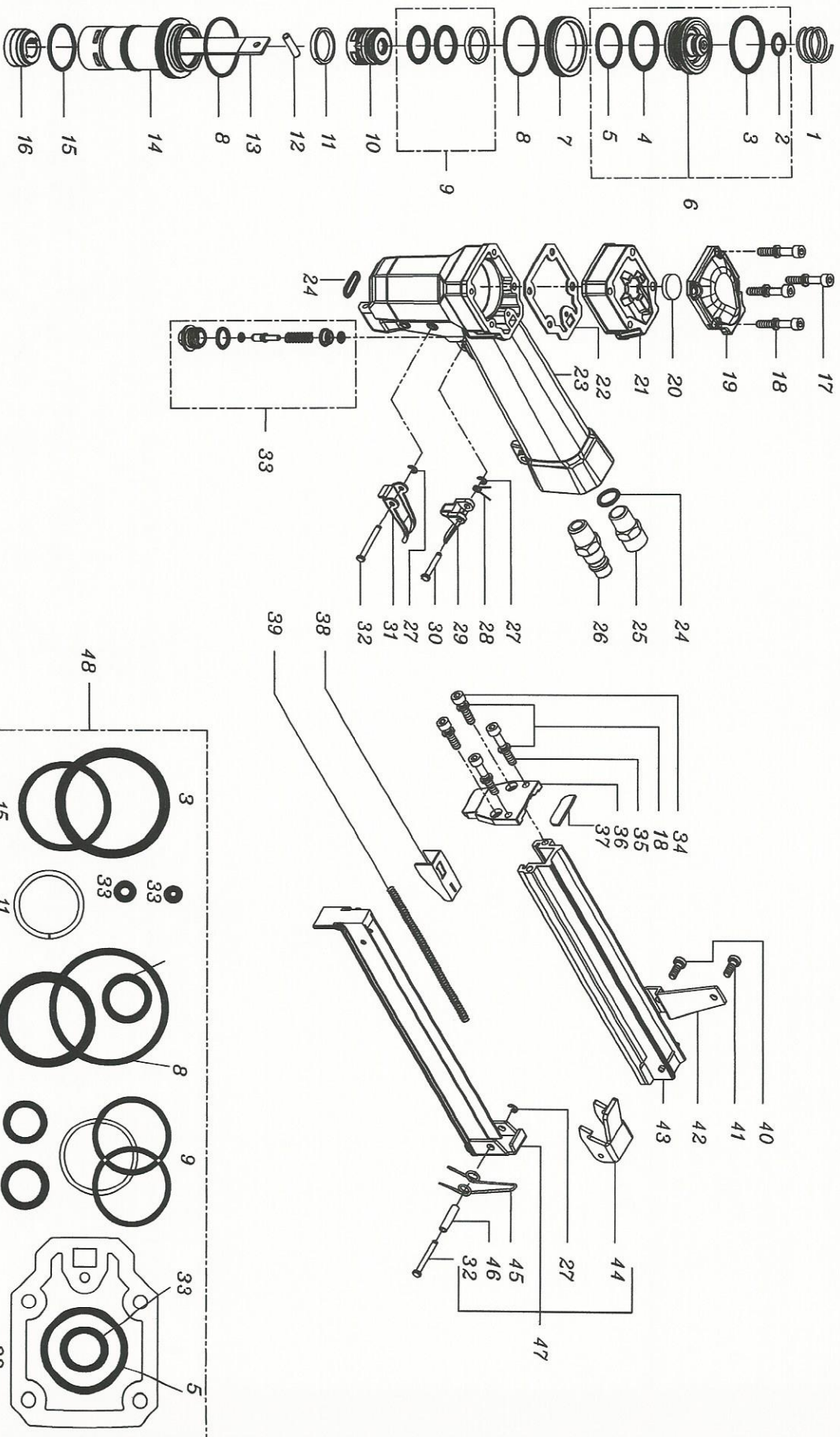



MODEL ST/16-11 PART LIST

DRAWING NUMBER	PART NUMBER	DESCRIPTION	ITEM QTY
1	RH92.01X	SPRING	1
2	RH00.12	O-RING	1
3	RH01.33	O-RING	1
4	RH01.29	O-RING	1
5	RH00.26	O-RING	1
6	RH40.04.2	VALVE ASS'Y	1
7	RH45.04	RING	1
8	RH00.35	O-RING	2
9	RH01.21.1	GASKET	1
10	RH30.07.3	PISTON	1
11	RH01.21.3	GASKET	1
12	RH14.18.1	PIN	1
13	RH22.00.83	DRIVER	1
14	RH26.07	CYLINDER	1
15	RH00.27	O-RING	1
16	RH32.05	BUMPER	1
17	RH04.35	SCREW	4
18	RH09.14	WASHER	8
19	RH25.04.1	EXHAUST DEFLECTOR	1
20	RH39.00	EXHAUST GASKET	1
21	RH22.07	HEAD	1
22	RH28.00	GASKET	1
23	RH20.00	BODY	1
24	RH00.14	O-RING	2
25	RH24.00	SILENCER	1
26	RH17.10	AIR PLUG 1/4"	1
27	RH09.02	O-RING	3
28	RH90.10	SPRING	1
29	RH81.15	SAFETY	1
30	RH76.14	PIN	1
31	RH81.09	TRIGGER	1
32	RH76.04	PIN	2
33	RH50.03	TRIGGER VALVE ASSEMBLY	1
34	RH04.16	SCREW	2
35	RH04.20	SCREW	2
36	RH91.01.83	NOSE PLATE	1
37	RH81.00.82	NOSE	1
38	RH70.00.83	PUSHER	1
39	RH93.02	SPRING	1
40	RH04.08	SCREW	1
41	RH04.12	SCREW	1
42	RH72.03.3	SUPPORT	1
43	RH53.00.83	SLIDER	1
44	RH80.08	TRIGGER	1
45	RH90.07	SPRING	1
46	RH76.45	PIN	1
47	RH62.00.83	MAGAZINE	1
48	RH00.70.5	O-RING KIT	1